

(1) Specifications:

- | | |
|-------------------------------|---|
| 1. Power supply | 100, 110, 200, 220, 230 V AC (as designated), 50/60 Hz, single phase. |
| 2. Power consumption | Normal 2W (MAX 30W) |
| 3. Standard time signal | Quartz oscillation |
| 4. Time accuracy | ± 3 seconds per week |
| 5. Security for power failure | Full operation of all functions after power failure, and memory back-up for subsequent 36 months. |
| 6. Use environment | Temperature: 0° C - 40°C
Humidity: 40% - 80% (without condensation) |
| 7. External dimensions | 190mm(W) X 210mm(H) X 130mm(D) |
| 8. Weight | Approx. 3 kg. |
| 9. Standard time card | 86mm(W) X 186mm(H) (Semi-monthly) |
| 10. Accessories | Operation manual 1 copy
Fuses 2 pcs Keys 2 pcs
Dust cover 1 pc |

(2)Features

1. Programmed control of work hours

Printing line, 2 color ribbon switching, IN/OUT position, internal melody and external time signal can be optionally set in 78 steps.

2. Weekly program

Day of the week can be programmed in weeks.

3. Automatic month-end adjustment

Month-end adjustment is automatically made irrespective of odd and even months or ordinary or leap year, if it is programmed.

4. Time signal function

Duration of time signal can be set from 0-99 seconds.

5. IN/OUT function

IN/OUT spacing position can be set by electronic programming.

6. Security for power failure (Applicable for models with back-up battery)

(1) Ni-Cd battery ensures printing full operation after power failure.

(2) When the battery voltage drops too low for the time to be printed, the LCD display goes out. Both time and programs are retained by a lithium battery for about 36 months.

(3) After power is restored, the time recorder will automatically advance to the present time.

7. Time display

(1) The display of digital series is a large, easy-to-read LCD. It shows date, AM/PM (when set to 12-hour system), time, day of week and other codes.

(2) The display of analog series uses pointers and a small LCD for display functions.

8. Special functions (overseas specifications)

Summer time control and automatic month-end adjustment by a special calendar are available.

* Functions vary with the model. See the table of functions by model on the preceding page.

* Specifications and functions are subject to change without notice for improvements.

2. PREPARATION

(1) Structure of time recorder

1) Name of Exterior Parts

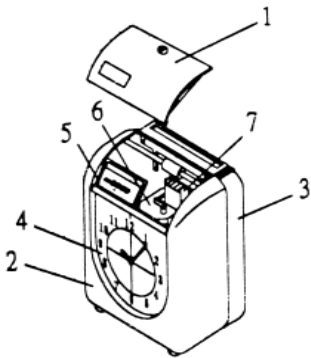

Analog series

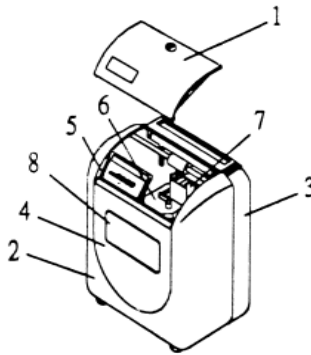

Digital series

1 Lid

2 Housing (front)

3 Back cover

4 Face clock

5 Small LCD

6 Ribbon cartridge

7 Print head

8 Large LCD

2) Battery Switch (applicable for back-up battery models)

a. Lie down the time recorder.

b. Turn the switch to "ON" position before installation.

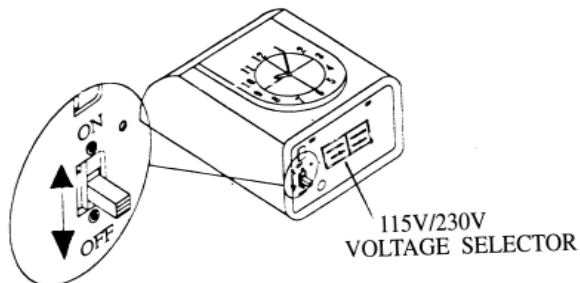

(1) Installation

Power source:

- 1) Use a power source with a stable voltage.
- 2) Use a power source which is independent from other equipment.

Installation:

Install the recorder on a stand 75 cm to 80 cm high.

Avoiding installing the machine in any of the following places:

- 1) Places where it may be exposed to the direct rays of the sun or high temperature such as a heater.
- 2) Places where temperature are extremely high.
- 3) Places where it may be exposed to rain water or high humidity conditions, resulting in condensation.





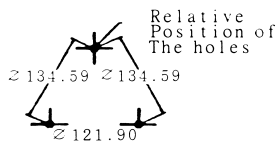
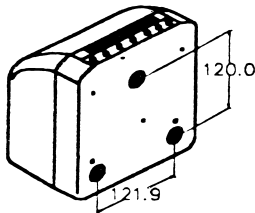



(3) Wall Mounting

- 1) Place 3 screws about 95 cm to 125 cm above the floor.
- 2) Hook the unit on the screws through the holes on the back cover, as shown in the figure.



3. SETTING

Open the lid with the power on to enter program status and use buttons on operation panel to set the program. The functions of each button listed as bellows:

								
PRO	IN MORNING	OUT	IN AFTERNOON	OUT	IN OVERTIME	OUT	+	-
P1	YR/MO/DT	TD/HR/MN	IMPRINT	SUMMER	PAYEND			
P2	DAY CH	LENGTH	BUZZER	RIBBON	I/O	ENTER		
P3	WEEKLY	H.L. ADJ.	SYNC	SEC.ZERO	V.L. ADJ.			

PRO: Press the "PRO" button to select the program group. In P1 status, press the "PRO" to enter P2 status, press the "PRO" again to enter P3 status.

CL: Press the + and - button at the same time to cancel the existing program contents.

(1) Setting of Year, Month and Date

Example: Change October 14, 1999 (Thursday) to November 22, 1999 (Monday)

1) Open the lid, the LCD displays P1.



2) Press F1 button.

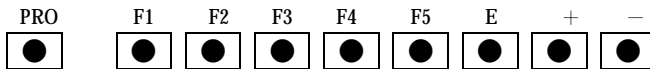

3) Press the + or - button to change the year to 99 and press the "E" button. If it is not necessary to change the year, press the "E" button.

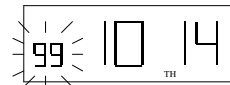

4) Press the + or - button to change the month to 11 and press the "E" button. If it is not necessary to change the month, press the "E" button.

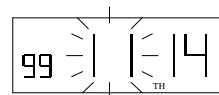

5) Press the + or - button to change the date to 22 and press the "E" button. If it is not necessary to change the date, press the "E" button.



6) Press the + or - button to change the day of week to MO and press the "E" button. If it is not necessary to change the day of week, press the "E" button.

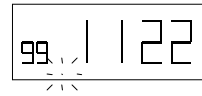

7) The LCD goes off, the setting is completed. Close the lid. If required, other settings can be performed before closing the lid.

(2) Setting of Time System, Hour and minute

Example: Change 15:14 PM, 24 hour display to 10:30 AM, 24 hour display.

1) Open the lid, the LCD displays P1



2) Press F2 button

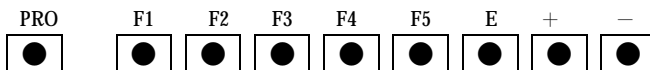

3) Press the + or - button to change the hour system to 24 and press the "E" button. If it is not necessary to change the time system, press the "E" button.



4) Press the + or - button to change the hour to 10 and press the "E" button. If it is not necessary to change the hour, press the "E" button.

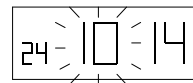

5) Press the + or - button to change the minute to 30 and press the "E" button. If it is not necessary to change the minute, press the "E" button.

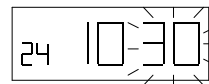

6) The LCD goes off, the setting is completed. Close the lid. If required, other settings can be performed before closing the lid.

(3) Setting imprint:

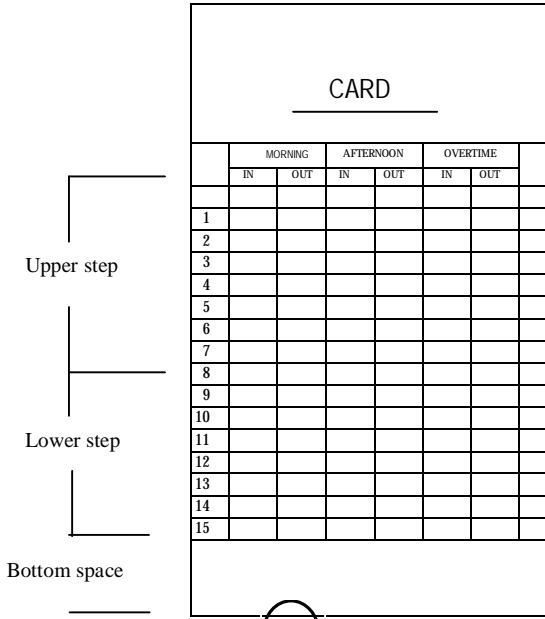

* The surface detection function operates only when you use our standard card (01 monthly pay cards) or an equivalent with a surface detection cut-out.

1) Card type can be selected from 01-10 the mode which applies to the card you use.

Card type	Value
Monthly pay (card surface detection operational)	01 (pitch 6mm)
Monthly pay (card surface detection not operational)	02 (pitch 6mm)
Weekly pay (Bottom space 23mm)	03 (pitch 6mm)
Weekly pay (Bottom space 35mm)	04 (pitch 6mm)
Weekly pay (Bottom space 70mm)	05 (pitch 7mm)
Weekly pay (Bottom space 23mm) (vertical)	06 (pitch 6mm)

Weekly pay (Bottom space 35mm) (vertical)	07 (pitch 6mm)
Weekly pay (Bottom space 70mm) (vertical)	08 (pitch 7mm)
* Special card (Bottom space 23mm) (vertical)	09 (pitch 6mm)
Full-monthly printing (Bottom space 5mm)	10 (pitch 5mm)
Monthly pay (Bottom space 23mm)	11 (pitch 6.1mm)
Upper step bi-weekly pay (bottom space 23mm)	12 (pitch 7mm)
Lower step bi-weekly pay (bottom space 23mm)	13 (pitch 7mm)
Upper step bi-weekly pay (bottom space 35mm)	14 (pitch 7mm)
Lower step bi-weekly pay (bottom space 35mm)	15 (pitch 7mm)
Weekly pay (Bottom space 23mm)	16 (pitch 7mm)
Weekly pay (Bottom space 23mm)	17 (pitch 7mm)

* Please refer P.21 Setting special card.

2) Minute indication can be selected from 01-04

Minute indication	Value
Minute	01
1/100 hour A	02
1/100 hour B	03
1/10 hour A	04

1/60 Hour	00	01	02	03	04	05	06	07	08	09	~	29	30	31	32	33	34	35	~	54	55	56	57	58	59
1/100 Hour A	00	02	03	05	07	08	10	12	13	15	~	48	50	52	53	55	57	58	~	90	92	93	95	97	98
1/100 Hour B	00	00	00	05	05	05	10	10	10	15	~	45	50	50	50	55	55	55	~	90	90	90	95	95	95
1/10 Hour	00	00	00	00	00	01	01	01	01	01	~	04	05	05	05	05	05	05	~	09	09	09	09	09	09

3) Day of the week indication

Imprint of day of week	Value	Example
No indication	00	Blank
Date	01	01, 02, ~31.
English	02	SU, MO, ~SA.
Italian	03	DO, LU, ~SA.
German	04	SO, MO, ~SA
French	05	DI,LU, ~SA.
Spanish	06	DO,LU, ~SA.
Japanese	07	日,月, ~ 土.
Number	08	D7,D1,D2, ~D6.

4) Example

Initial value of card type and imprint is 02 01 01, monthly pay card with card surface detection not operational, minute indication in minute and day of the week indication in date.

To change to lower step weekly pay (bottom space 35mm), minute indication in minute and day of the week indication in English, perform the following:

- a. Open the lid, the LCD displays P1.



- b. Press F3 button.

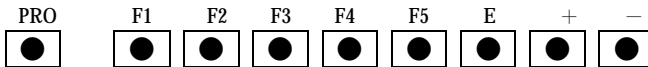

- c. Press the + or - button to change the card type and press the "E" button. If it is not necessary to change the type, press the "E" button.

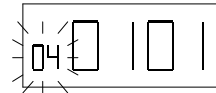

- d. Press the + or - button to change the minute indication and press the "E" button. If it is not necessary to change it, press the "E" button.

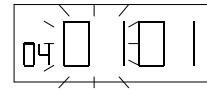

- e. Press the + or - button to change the day of the week indication and press the "E" button. If it is not necessary to change it, press the "E" button.

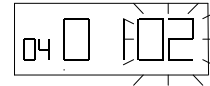

- f. The LCD goes off, the setting is completed. Close the lid. If required, other settings can be performed before closing the lid.

(4) Setting summer time

To set summer time, there are 2 options. Option 1: by date, option 2: by weekly. Each option has 2 programs that must be set simultaneously. Set program 1 to start summer time, program 2 to end summer time.

Example 1: (Option 1: by date)

Starting date and time: April 1, 02:00

Ending date and time: October 1, 02:00

At 2:00 AM on the first day of summer time, the clock automatically gains one hour to show 3:00 AM.

When 2:00 AM comes on the last day of summer time, it loses one hour and return to 1:00 AM.

- a. Open the lid, the LCD displays P1.



- b. Press F4 button.

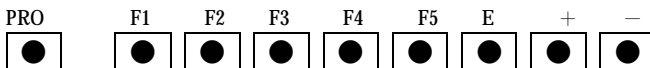

- c. Press the + or - button to change option 1, and press the "E" button.

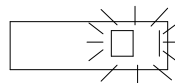

- d. Press the + or - button to change the hour to 2 and press the "E" button. If it is not necessary to change it, press the "E" button.



- e. Press the + or - button to change the month to 04 (April) and press the "E" button. If it is not necessary to change it, press the "E" button.

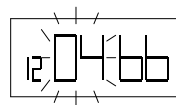

- f. Press the + or - button to change the day to 01 and press the "E" button. If it is not necessary to change it, press the "E" button.

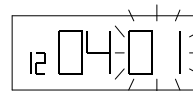

- g. The LCD will display as shown and the setting of the ending date will start.



- f. Press the + or - button to change the day to 01 and press the "E" button. If it is not necessary to change it, press the "E" button.

- h. Following the above procedures from step (d) to set the ending date of summer time.

- i. The LCD goes off, the setting is completed. Close the lid. If required, other settings can be performed before closing the lid.

Example 2: (Option 2: by weekly)
 Starting date and time: 2004/3/28 SUN
 Ending date and time: 2004/9/26 SUN

If set as the above, the unit remembers the start date as the last Sunday of March and the end date as the last Sunday of October. Once set, the unit automatically updates the setting every year thereafter. No further manual setting is necessary.

At 2:00 AM on the first day of summer time, the clock automatically gains one hour to show 3:00 AM.

When 3:00 AM comes on the last day of summer time, it loses one hour and return to 1:00 AM.

- a. Open the lid, the LCD displays P1.



- b. Press F4 button.

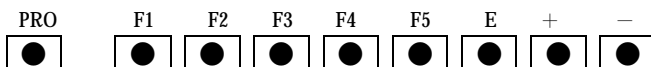

- c. press the + or - button to change option 2, and press the "E" button.

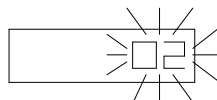

- d. Press the + or - button to change the year to 04 and press the "E" button. If it is not necessary to change it, press the "E" button.

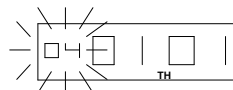

- e. Press the + or - button to change the month to 03 (May) and press the "E" button. If it is not necessary to change it, press the "E" button.

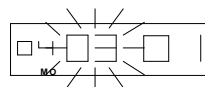

- f. Press the + or - button to change the day to 28 and press the "E" button. If it is not necessary to change it, press the "E" button. And then the "SU" is blinking, press "E" button again. The starting date of summer time has been set.

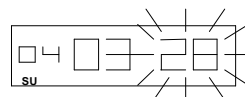

g. The LCD will display as shown and the setting of the ending date will start.

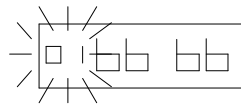

h. Following the above procedures from step (d) to set the ending date of summer time.

(5) Changing pay period ending date

Initial value of pay ending date is 31 01 FR, monthly pay ending date is 31, weekly pay ending date is Friday and the 1st row is set as a blank row.

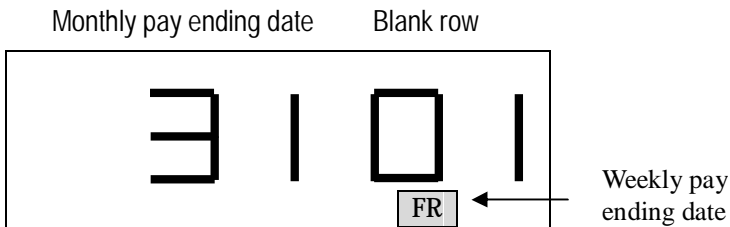

CARD						
	MORNING		AFTERNOON		OVERTIME	
	IN	OUT	IN	OUT	IN	OUT
1						
2						
3						
4						
5						
6						
7						
8						
9						
10						
11						
12						
13						
14						
15						

1st row
Blank row

16th row

Card surface

CARD						
	MORNING		AFTERNOON		OVERTIME	
	IN	OUT	IN	OUT	IN	OUT
16						
17						
18						
19						
20						
21						
22						
23						
24						
25						
26						
27						
28						
29						
30						
31						

17th row

32nd row

Card back

1) Change pay ending date (Monthly pay)

A blank row means a row is left blank out of the 32 rows on the

surface and back of a time card. Printing position of pay ending date is one row above the blank row.

Example: Change the pay ending date to 20th and blank row to 16th row, perform the following:

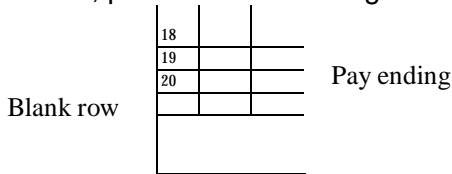

a. Open the lid, the LCD displays P1.



b. Press F5 button.

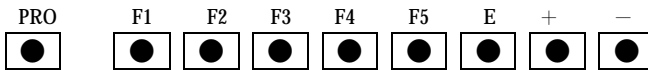

c. Press the + or - button to change the pay ending date to 20 and press the "E" button. If it is not necessary to change it, press the "E" button.

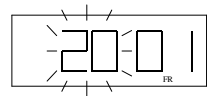

d. Press the + or - button to change the blank row to 16 and press the "E" button. If it is not necessary to change it, press the "E" button.

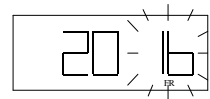

e. The day of week will blink. Press the "E" button, the LCD goes off, the setting is completed. Close the lid. If required, other settings can be performed before closing the lid.

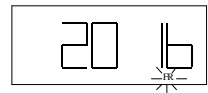

2) Change pay ending day (Weekly pay)

Printing format of weekly card have two styles: horizontal and vertical style. Pay ending date for horizontal style card is set at the last row of the time card. While vertical style card has no imprint for pay ending date.

Example: Change the pay ending date to Sunday, perform the following:

a. Open the lid, the LCD displays P1



b. Press F5 button.

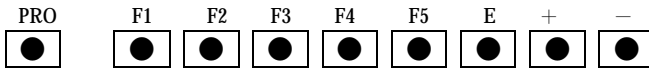

c. Press the "E" button twice, the day of week will blink. Press the + or - button to change the day of week to SU and press the "E" button.

The LCD goes off, the setting is completed.
Close the lid. If required, other settings can be performed before closing the lid.



* Please refer to the imprint setting for weekly pay card selection.

Horizontal weekly card
Pay ending day is Sunday

NO. _____						
NAME _____						
	MORNING		AFTERNOON		OVERTIME	
	IN	OUT	IN	OUT	IN	OUT
MO						
TU						
WE						
TH						
FR						
SA						
SU						

Vertical weekly card
Pay ending day is Sunday

NO. _____							
NAME _____							
	MON	TUE	WED	THU	FRI	SAT	
IN							
OUT							
IN							
OUT							
IN							
OUT							

(6) Day time change

The initial value for day time change has been set at 00 00. The print row is changed at 00:00.

Example: Set the day time change at 03:30 AM, perform the following:

1) Open the lid, the LCD displays P1.



2) Press the PRO button, the LCD displays P2.

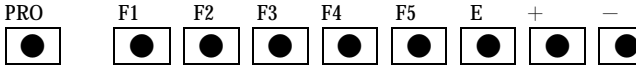

3) Press F1 button and use the + or - button to change the hour of day change to 03 and press the "E" button. If it is not necessary to change it, press the "E" button.

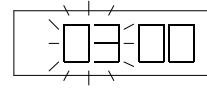

4) Press the + or - button to change the minute of day change to 30 and press the "E" button. If it is not necessary to change it, press the "E" button.

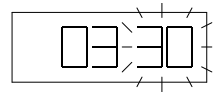

(7) Changing time signal length

Initial value of time signal length has been set to 05. The length of time signal is 5 seconds.

Example: Change the initial value to 10 seconds, perform the followings:

a. Open the lid, the LCD displays P1.



b. Press the PRO button, the LCD displays P2.

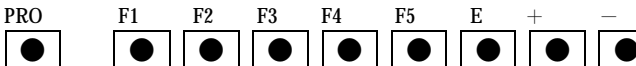

c. Press F2 button and use the + or - button to change the seconds to 10 and press the "E" button. The LCD goes off, the setting is completed. Close the lid. If required, other settings can be performed before closing the lid.

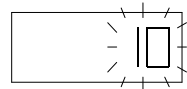

(8) Setting time signal

Totaling 42 programs can be set and can be operated at any given

time or on any day of the week.

Example: Set a time signal sound at 8:00, Monday to Friday, and at 05:00 PM, every day of the week. Perform the followings:

- 1) Open the lid, the LCD displays P1.



- 2) Press the PRO button, the LCD displays P2.

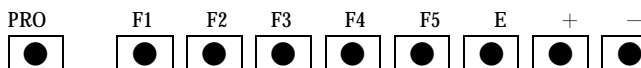

- 3) Press F3 button and use the + or - button to change the hour to 08 and press the "E" button. If it is not necessary to change it, press the "E" button.

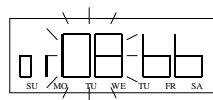

- 4) Press the + or - button to change the minute to 00 and press the "E" button. If it is not necessary to change it, press the "E" button.

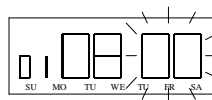

- 5) Day of week display SU will blinking, then press the "E" button to register the setting. When the next program number 02 66 66 appears, the registration is completed.

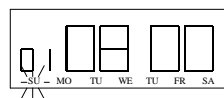

- 6) Press the + or - button to change the hour to 17 and press the "E" button. If it is not necessary to change it, press the "E" button.

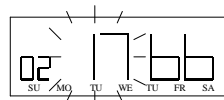

- 7) Press the + or - button to change the minute to 00 and press the "E" button. If it is not necessary to change it, press the "E" button.

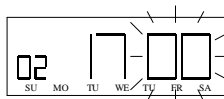

- 8) Day of week display SU will blinking, press + button to add the day that time

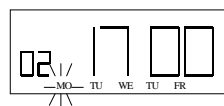

signal is sounded and press - button to cancel the time signal. To register the setting, press the "E" button.

When the next program number 03 66 66 appears, the registration is completed. Close the lid.

* Changing (confirming) the time signal setting

1) Open the lid, the LCD displays P1.



2) Press the PRO button, the LCD displays P2.



3) Press F3 button, the LCD will display data of group 1 you have just entered. If you don't want to change it, press F3 button to move to group 2. Following this procedure to the specific group you want to change (confirm). Press + and - button at the same time to delete the data and enter the correct time of signal. Press the "E" button to register it. When the next program number appears, the registration is completed.

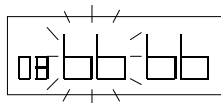

(9) Setting time of ribbon color change

Totaling 18 programs can be set and can be operated at any given time or on any day of the week. Odd groups imprint RED color, Even groups imprint BLUE color.

Example: RED printing at 08:01 (all days of week) and BLUE printing at 17:00 (from Monday to Friday). Perform the following:

1) Open the lid, the LCD displays P1.



2) Press the PRO button, the LCD displays P2.

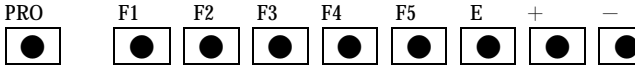

3) Press F4 button and use the + or - button to change the hour to 08 and press the "E" button. If it is not necessary to change it, press the "E" button.

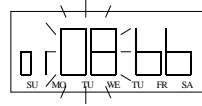

4) Press the + or - button to change the minute to 01 and press the "E" button. If it is not necessary to change it, press the "E" button.

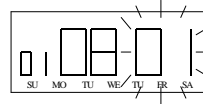

5) Day of week display SU will blinking, then press the "E" button to register the setting. When the next program number 02 66 66 appears, the registration is completed.

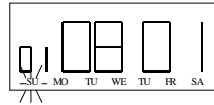

6) Press the + or - button to change the hour to 17 and press the "E" button. If it is not necessary to change it, press the "E" button.

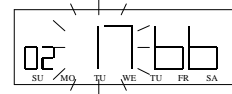

7) Press the + or - button to change the minute to 00 and press the "E" button. If it is not necessary to change it, press the "E" button.

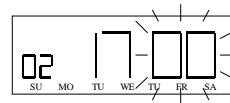

8) Day of week display SU will blinking, press + button to add the day that ribbon color change is switched and press - button to cancel the color change. To register the setting, press the "E" button. When the next program number 03 66 66 appears, the registration is completed. Close the lid.

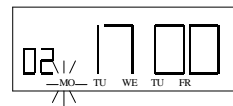

* Changing (confirming) the ribbon color change setting

1) Open the lid, the LCD displays P1.



2) Press the PRO button, the LCD displays P2.



3) Press F4 button, the LCD will display data of group 1 you have just entered. If you don't want to change it, press F4 button to move to group 2. Following this procedure to the specific group you want to change (confirm).

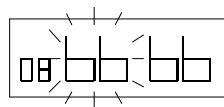

Press + and - button at the same time to delete the data and enter the correct time for color change. Press the "E" button to register it. When the next program number appears, the registration is completed.

(10) Setting time of IN/OUT auto-shift position

Totalling 18 programs can be set and can be operated at any given time or on any day of the week.

The position code has to be entered before input the time of auto-shift. The position code as follows:

11	Morning	IN	12	Morning	OUT
13	Afternoon	IN	14	Afternoon	OUT
15	Overtime	IN	16	Overtime	OUT

Example: Morning IN 07:00 (everyday)

Afternoon OUT 04:00 PM (from Monday to Friday)

1) Open the lid, the LCD displays P1.



2) Press the PRO button, the LCD displays P2.



3) Press F5 button and use the + or - button to change the position code to 11 and press the "E" button. If it is not necessary to



change it, press the "E" button.

- 4) Press the + or - button to change the hour to 07 and press the "E" button. If it is not necessary to change it, press the "E" button.

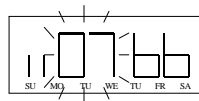

- 5) Press the + or - button to change the minute to 00 and press the "E" button. If it is not necessary to change it, press the "E" button.

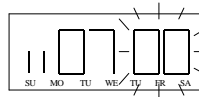

- 6) Day of week display SU will be blinking, then press the "E" button to register the setting. When the next program number 12 66 66 appears, the registration is completed.

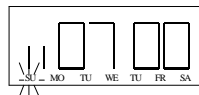

- 7) Press the + or - button to change the position code to 14 and press the "E" button.

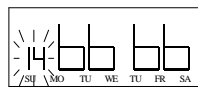

- 8) Press the + or - button to change the hour to 16 and press the "E" button. If it is not necessary to change it, press the "E" button.

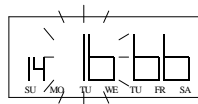

- 9) Press the + or - button to change the minute to 00 and press the "E" button. If it is not necessary to change it, press the "E" button.

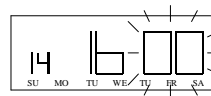

- 10) Day of week display SU will be blinking, press + button to add the day that auto-shift is operational and press - button to cancel this function. To register the setting, press the "E" button. When the next program number 15 66 66 appears, the registration is completed. Close the lid.

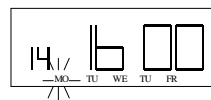

* Changing (confirming) the time of IN/OUT auto-shift position

- 1) Open the lid, the LCD displays P1.



2) Press the PRO button, the LCD displays P2.

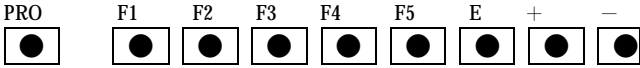

3) Press F5 button, the LCD will display data of group 1 you have just entered. If you don't want to change it, press F5 button to move to group 2. Following this procedure to the specific group you want to change (confirm). Press + and - button at the same time to delete the data and enter the correct time for auto-shift.

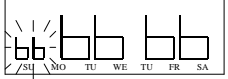

(11) Setting weekly printing (SPECIAL CARD)

Totaling 16 programs can be set. Applicable only for card type 9, please refer to section 3 setting imprint for card type selection. The time card has 16 rows on the surface. The setting group 1 imprint on row 1, group 2 imprint on row 2 and so on. Example: 08:00 AM imprint on row 1, 01:00 PM imprint on row 8, pay ending day is Sunday, perform the following:

1) Open the lid, the LCD displays P1.



2) Press the PRO button twice, the LCD displays P3.

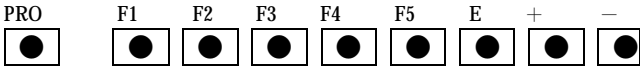

4) Press F1 button and use the + or - button to change the hour to 08 and Press the "E" button.

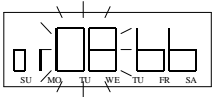

If it is not necessary to change it, press the "E" button.

4) Press the + or - button to change the minute to 00 and press the "E" button. If it is not necessary to change it,

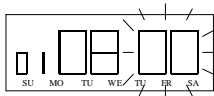

press the "E" button.

- 5) Day of week display SU will blinking, press + button to add the day that is operational and press - button to cancel this operation. To register the setting, press the "E" button to enter the next program.

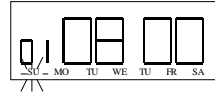

- 6) Press F1 button repeatedly to select group 8 and use the + or - button to change the hour to 13 and then press the "E" button. If it is not necessary to change it, press the "E" button.

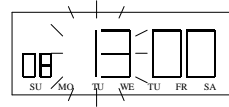

- 7) Press the + or - button to change the minute to 00 and press the "E" button. If it is not necessary to change it, press the "E" button.

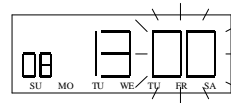

- 8) Day of week display SU will blinking, press + button to add the day that is operational and press - button to cancel this operation. To register the setting, press the "E" button to enter the next program.

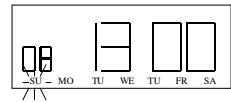

* Changing (confirming) the setting

Perform step 1 and step 2, and press F1 button to select the specific group you want to change (confirm). Then perform the procedure from step 3 to change the time.

Lower step weekly pay, pay ending day is Sunday.
Bottom space 23mm.

考 勤 卡						
	MON	TUE	WED	THU	FRI	SAT
1						

2								
3								
4								
5								
6								
7								
8								
9								
10								
11								
12								
13								
14								
15								
16								

_____ 23mm _____

4. SPECIAL FUNCTIONS:

- 1) Synchronies: Press the "PRO" button to enter P3, then press F3 button to advance the clock one minute and the clock will begin at 00 seconds. Each time the F3 button is pressed, the clock advance one minute.

- 2) Second reset: Press the "PRO" button to enter P3, then press F4 button to stop the second counting and the clock will automatically start from 00 seconds.

- 3) Horizontal adjust: If the printing is off the center of the column, perform the following to adjust it. Press the "PRO" button to enter P3 programming status, then press the "F2" button. Use the + or - button to move to the desired value and press the "E" button to register it. The initial value is 50.
 Increase the value larger than 50 will print rightwards. Decrease the value smaller than 50 will print leftwards. Value +1 or -1 will adjust the print 0.125mm each.

- 4) Vertical adjust: If the printing is off the center of the row, perform the following to adjust it. Press the "PRO" button to enter P3 programming status, then press the "F5" button. Use the + or - button to move to the desired value and press the "E" button to register it. The initial value is 50.
 Increase the value larger than 50 will print upwards. Decrease the value

smaller than 50 will print downwards. Value +1 or -1 will adjust the print 0.5mm each.

5) RESET switch: Press the SW1 switch on the main PC board, all of the data is removed and back to initial value.

5. HOW TO CONNECT AN EXTERNAL SIGNAL UNIT

The connecting wires of output time signal are under the time recorder. Please install the external signal unit referring to the follow drawing.

If the current consumption of external siren or bell exceeds 1A, you are requested to install an additional relay to control buzzer.

The power supply of external siren or bell must be independent.

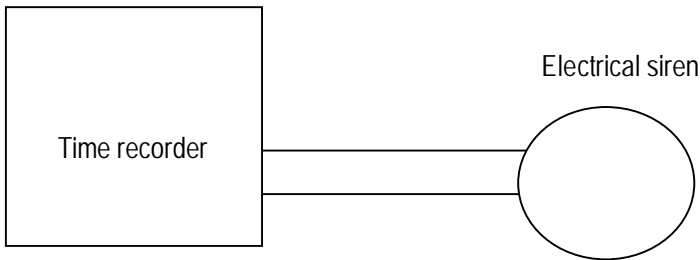
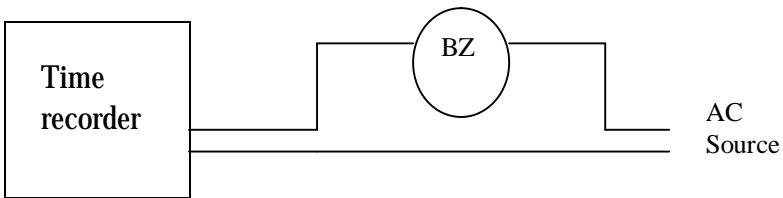

6. REPLACEMENT OF RIBBON CARTRIDGE

- 1) Insert the key into the keyhole.
(figure 1)
- 2) Turn the key clockwise.
(figure 1)
- 3) Remove the lid. (figure 2)
- 4) Hold the cartridge by thumb pressing A, first and middle finger pressing B.
- 5) Pull the cartridge up in the direction C: (figure 3)
- 6) Insert a new cartridge between the print head and the guide plate and turn the knob clockwise.
- 7) Connect the joints in the cartridge with the slots in the ribbon base. Push the cartridge head until it clicks into place.
- 8) Turn the knob clockwise to remove any slackness in the ribbon.
- 9) Connect the hooks in the lid (A, B) with the hooks in the case (C, D). Bring the lid down until it is inserted into place.
(figure 4)
- 10) Insert the key and turn the key counterclockwise.

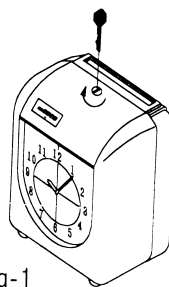

Fig-1

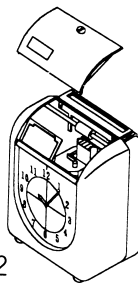

Fig-2

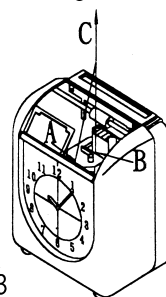

Fig-3

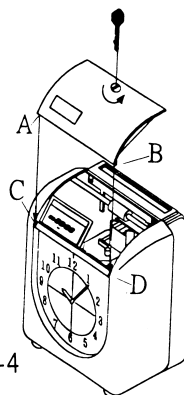

Fig-4

7.HOW TO REMOVE AND INSTALL THE CASE AND BACK COVER

1) Case removing and installation

- a. Open the lid (refer to the figure 1 and 2)
- b. Use a (+) screw driver to remove (A ,B) 2 screws. (figure 5)
- c. Lie down the time recorder.
- d. Use a (-) screw driver to push the plastic joints in the rectangle holes. (figure 6)

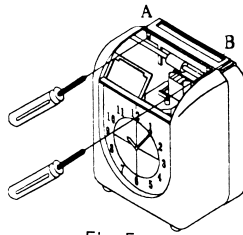

Fig-5

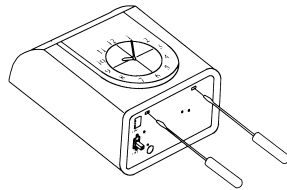

Fig-6

2) Back cover removing

- a. Use a small (-) screw driver to remove the plastic rivet (A). Remove the LCD PC board. (figure 7)
- b. Use a (+) screw driver to remove 2 screws (B).
- c. Turn the time recorder around.
- d. Use a (+) screw driver to remove 2 screws (C, D). (figure 8)
- e. Bring the back cover toward you to remove it.
- f. To install the back cover, follow the above procedures reversibly.

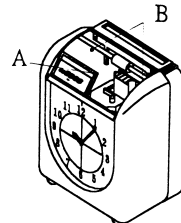

Fig-7

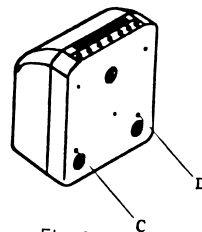

Fig-8

8. TROUBLESHOOTING

1) The time recorder doesn't accept time card:

- a. Power failure, or
- b. The power cord is disconnected, or
- c. Time card sensor malfunctions, please contact immediately the dealer from whom you bought the time recorder.

2) A long "beep" is heard without printing:

The card was inserted backwards, please insert the card the other way round. If the time recorder does not return to normal, please contact the dealer.

3) Incorrect printing:

Incorrect setting of time, please reset the time.

4) The printing position is wrong:

Incorrect setting of pay period ending date, etc. Please set them correctly.

5) Light printing:

- a. The ribbon is worn out, please replace the ribbon cassette.
- b. The ribbon cassette is not set correctly, please set it.

6) Printed time does not agree with the clock displayed time:

Disconnect the power and re-plug it. If the LCD displays EC0, the clock movement malfunctions. Please contact the dealer.

7) The time recorder does not run:

- a. Check if the fuse on the power supply PC board blow out.
- b. Press the RESET button on the main PC board. If it does not work, please contact the dealer.

8) List of error codes:

- a. EC0: Error of clock movement (Maybe clock sensor pc board).
- b. EC1: Error of motor (Maybe horizontal motion is not smoothly).
- c. EC2: Error of motor (Maybe vertical motion is not smoothly).
- d. EC3: Error of time card detection sensor (Maybe sensor surface dirty).

Caution: Improper connection or disposal of rechargeable battery may Result in fire or explosion. Replace with Ni-Cd, type J-AA, 900mAH * 12, rate at 1.2V.